

SINGER
20U

CSTMP

MACHINE PARTS CHART
for

SINGER*

2 0 U

CSMP

SINGER*

20U

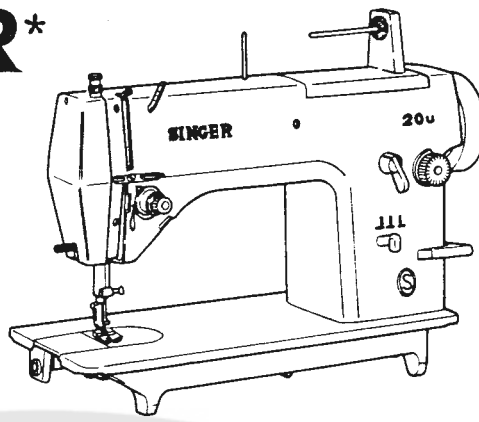

504094

505513

541709



52454

504

541709

52024



52130



54170E

549046(2)

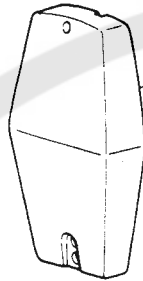

541644

504083



11170

505343



504028

56046

541720

541725

99665



549330

540472



504010

541698

504159

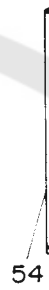

541657



541666

504150



549290

541752

541732

173616

541668

541758

541667

541669

504027

541669

541669

541669

541669

541669

541669

541669

541669

541669

541669

541669

541669

541669

541669

541669

541669

541669

541669

541669

541669

541669

541669

541669

541669

541669

541669

541669

541669

541669

541669

541669

52016



504056

505658

36555



541700



541759



549354



541701



545260



541620

541619



154884



154789(2)

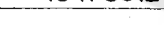

504063



541700

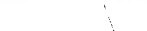

541759



549354



541701

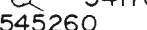

545260



541620

541619



154884



154789(2)

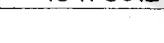

504063



541700



541759



549354



541701

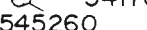

545260



541620

541619



154884



154789(2)

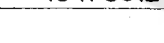

504063



541700



541759



549354



541701

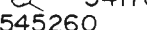

545260



541620

541619



154884



154789(2)

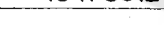

504063



541700



541759



549354



541701



545260



541620

541619



154884



154789(2)

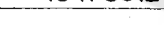

504063



541700



541759



549354



541701

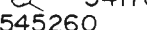

545260



541620

541619



154884



154789(2)

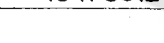

504063



541700



541759



549354



541701

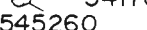

545260



541620

541619



154884



154789(2)

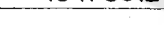

504063



541700



541759



549354



541701



545260



541620

541619



154884



154789(2)

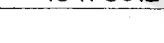

504063



541700



541759



549354



541701

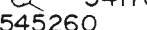

545260



541620

541619



154884



154789(2)

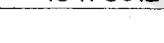

504063



541700



541759



549354



541701

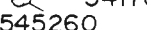

545260



541620

541619



154884



154789(2)

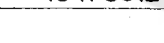

504063



541700



541759



549354



541701

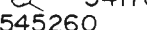

545260



541620

541619



154884



154789(2)

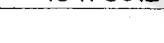

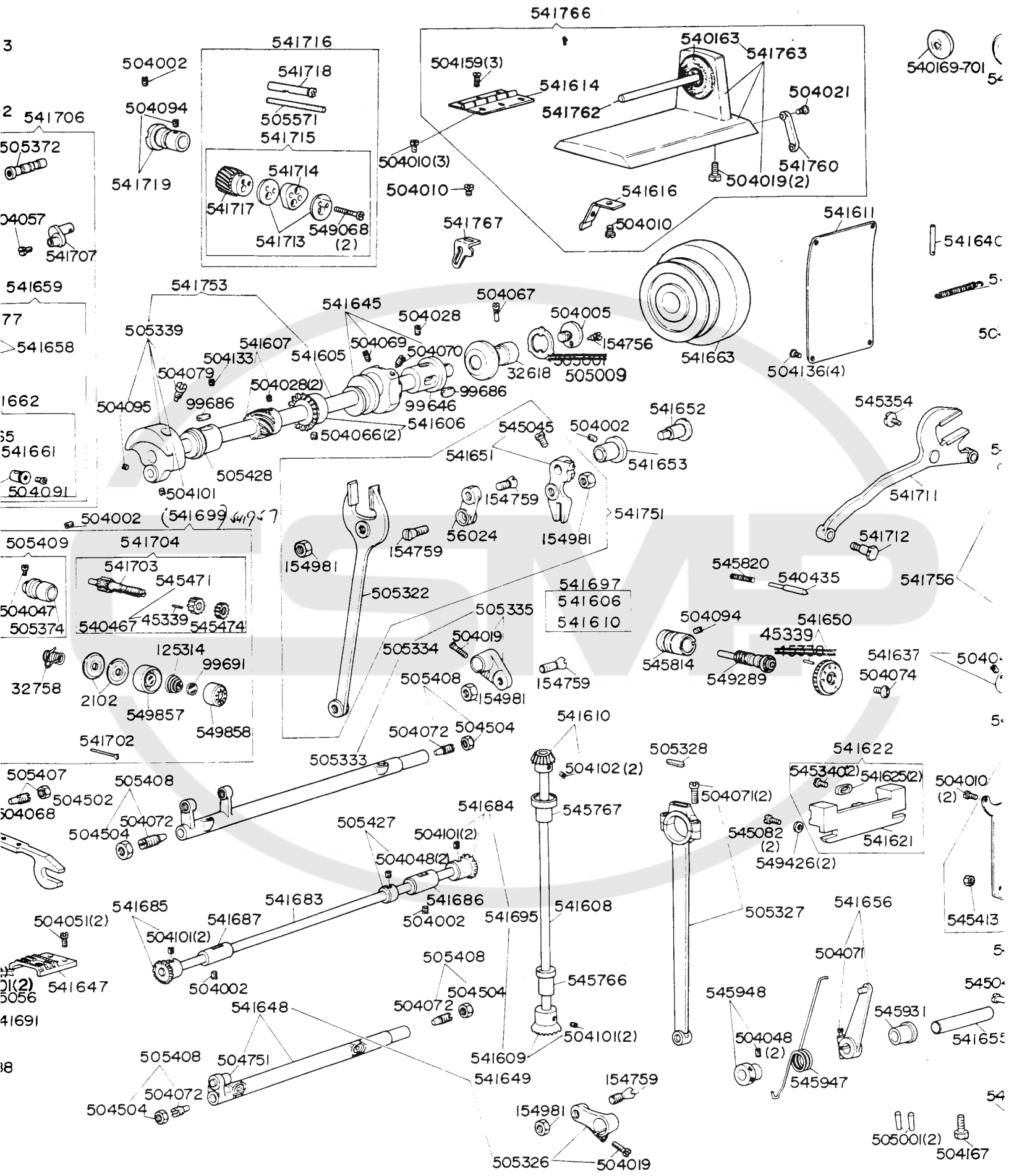

ALTERATIONS - 20U PARTS CHART FORM U209

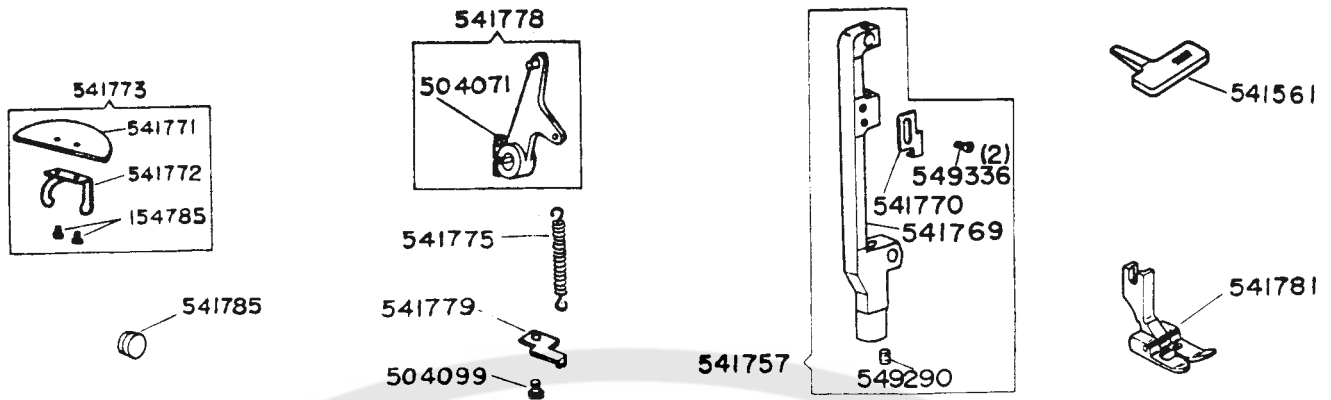

- Alter:** 504002 (850) Feed Regulator Hinge Stud Flanged Bushing Set Screw to 504029 (833)
 504051 (850) Feed Dog Screw (2) to 549376 (850)
 504079 (830) Needle Bar Crank Position Screw to 504120 (803)
 504134 (803) Bight Amplitude Slide Block Guide Stud Set Screw to 545098 (850)
 504136 (825) Arm Side Cover Set Screw (4) to 549336 (825)
 541618 Bed Plate to 541771
 541638 Bight Amplitude Slide Block Crank Shaft Knob to 541774
 541644 Face Plate to 541768
 541655 Feed Reverse Lever Hinge Stud to 541780
 541656 Feed Reverse Lever Link with 504071 to 541778
 541666 Needle Bar Frame to 541769
 541710 Throat Plate to 541783
 541765 Rotating Hook Section to 505360
 545205 (833) Bight Amplitude Slide Block Crank Set Screw (2) to 545246 (803)
 549046 (853) Face Plate Screw (2) to 545386 (850)
- Delete:** 504048 (833) Feed Reverse Lever Hinge Stud Collar Set Screw (2)
 504159 (819) Bed Plate Screw (2)
 545947 Feed Reverse Lever Link Spring
 545948 Feed Reverse Lever Hinge Stud Collar with two 504048
- Add:** 154785 (809) Bed Plate Bracket Screw (2)
 504099 Feed Reverse Lever Return Spring Bracket Screw
 541770 Needle Bar Timing Indicator Plate
 541772 Bed Plate Bracket
 541773 Bed Plate Complete Nos. 541771, 541772 and two 154785
 541775 Feed Reverse Lever Return Spring
 541779 Feed Reverse Lever Return Spring Bracket (hook)
 541785 Arm Plug
 549336 (825) Needle Bar Timing Indicator Plate Screw (2)

ATTACHMENT and ACCESSORIES

- Alter:** 541670 Presser Foot (spring hinged) to 541566
- Add:** 541561 Screw Driver
 541781 Presser Foot (for buttonholing)

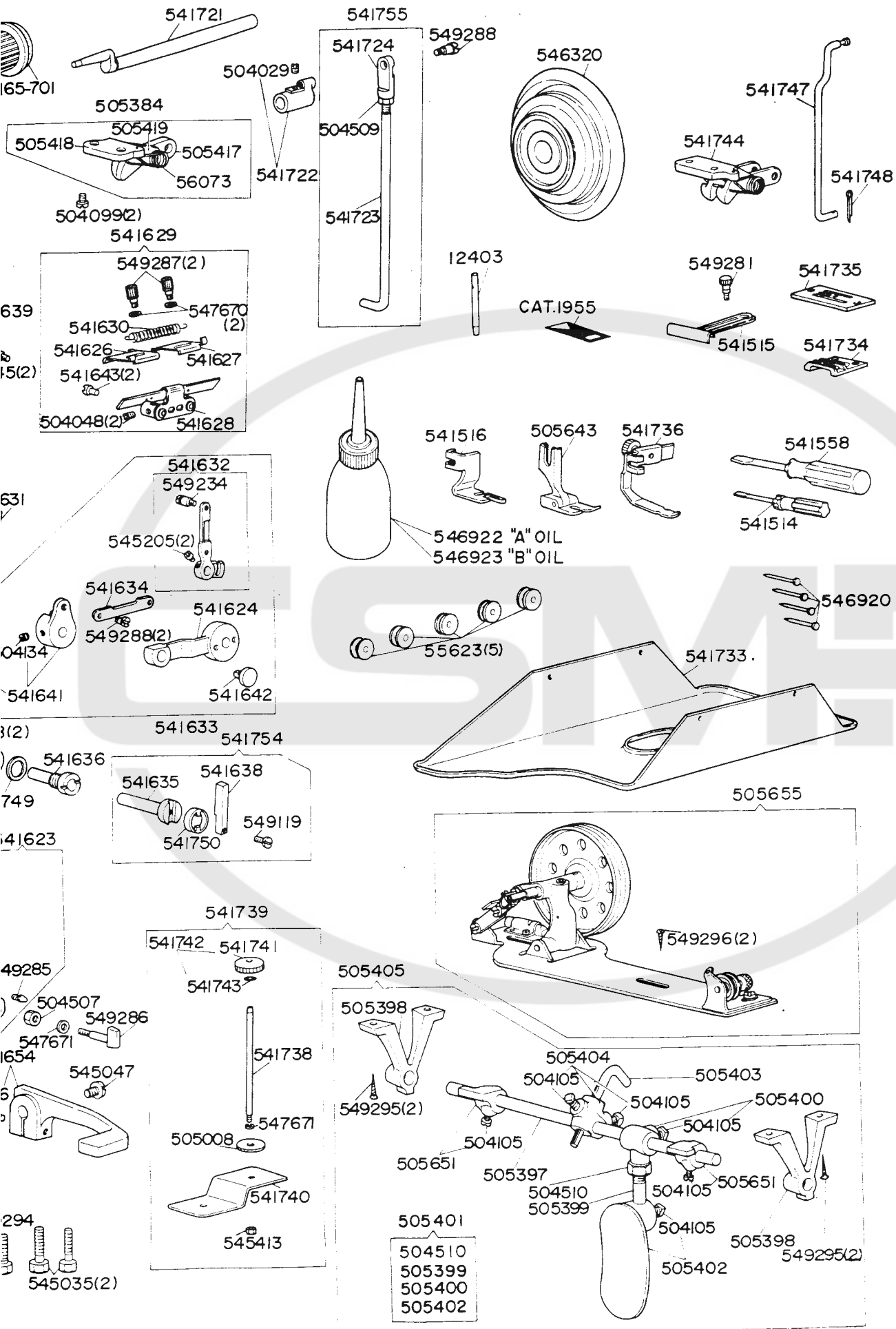

NUMERICAL LIST OF PARTS FOR MACHINE 201

<u>PART NO.</u>	<u>DESCRIPTION</u>	<u>PART NO.</u>	<u>DESCRIPTION</u>
541720	Presser Bar Lifting Bracket with 541725 and 549330	549354 (850)	Needle Bar Frame Clamping Stud Screw
541721	Presser Bar Lifting Shaft	549426	Bight and L-C-R Position Block Washer (2)
541722	Presser Bar Lifting Shaft Arm with 504029	549857	Tension Indicator
541723	Presser Bar Lifting Shaft Arm Connecting Rod	549858	Tension Indicator Flange
541724	Presser Bar Lifting Shaft Arm Connecting Rod Joint	Cat. No. 1955	Needle (size No. 14) with Pontoon C.A.E.
<u>ACCESSORIES</u>			
541725	Presser Bar Lifting Shaft Link	12403	Arm Spool Pin and Thread Eyelet
541732	Thread Guard (lower)	55623	Rotating Hook Bobbin (5)
541749	Bight Amplitude Slide Block Crank Shaft Bushing Washer	505008	Bobbin Winder Spool Pin Washer (felt)
541750	Bight Amplitude Slide Block Crank Shaft Ring	505643	Presser Foot (spring hinged) complete, (for straight stitching)
541751	Feed Forked Connection 505322 with 56024, 541651, two each 154981 and 154759	505655	Universal Bobbin Winder complete, with two 549296
541752	Thread Guard (lower) Bracket (body)	540165 (701)	Arm Top Cover Spool Holder Thread Lead-off (large)
541753	Arm Shaft (horizontal) and Needle Bar Crank complete, Nos. 541605 and 505339	540169 (701)	Arm Top Cover Spool Holder Thread Lead-off (small)
541754	Bight Amplitude Slide Block Crank Shaft Knob 541638 with 541635, 549119 and 541750	541514	Screw Driver (small)
541755	Presser Bar Lifting Shaft Arm Connecting Rod 541723 with 541724 and 504509	541515	Cloth Guide
541756	Bight Amplitude Slide Block Guide 541641 with 541631	541516	Hemmer Foot (1/8 in. hem)
541757	Needle Bar Frame 541666 with 549290	541558	Screw Driver (large)
541758	Needle Bar (hollow) 541657 with 541757	541734	Feed Dog (for straight stitching)
541759	Needle Bar Frame Clamping Stud	541735	Throat Plate (for straight stitching)
541760	Arm Top Cover Shutting Plate Link	541736	Zipper Foot
541762	Arm Top Cover Spool Holder	541738	Bobbin Winder Spool Pin
541763	Arm Top Cover with Spool Holder Bracket, Nos. 540163 and two 504019	541739	Bobbin Winder Spool Pin complete, Nos. 541738, 547671, 505008, 541740, 541742 and 545413
541764	Rotating Hook Bobbin Case Tension Spring	541740	Bobbin Winder Spool Pin Bracket
541765	Rotating Hook Section	541741	Bobbin Winder Spool Presser Plate (body)
541766	Arm Top Cover complete, Nos. 504010, 504021, 541614, 541616, 541760, 541762, 541763 and three 504159	541742	Bobbin Winder Spool Presser Plate complete, Nos. 541741 and 541743
541767	Arm Top Cover Shutting Plate	541743	Bobbin Winder Spool Presser Plate O-Ring
545001 (819)	Needle Bar Connecting Stud Hinge Pin Screw	545413 (850)	Bobbin Winder Spool Pin Nut
545035 (805)	Arm Screw (2)	546922	Oiler (130 cc, filled with Singer Type "A" Oil) (for treadle drive)
545045 (833)	Feed Regulator Hinge Stud Set Screw	546923	Oiler (130 cc, filled with Singer Type "B" Oil) (for electric drive)
545046 (809)	Feed Reverse Lever Set Screw	547671	Bobbin Winder Spool Pin Spring Washer
545047 (850)	Feed Reverse Lever Hinge Stud Cap Screw	549281 (802)	Cloth Guide Screw
545056 (833)	Rotating Hook Shaft Bushing (long) Set Screw	549296 (819)	Bobbin Winder Wood Screw (5.5 x 19) (2)
545056 (833)	Rotating Hook Shaft Bushing (short) Set Screw	Cat. No. 1955	Needle (size No. 14) with Pontoon C.A.E. (3)
545082 (803)	Bight and L-C-R Position Block Set Screw (2)	<u>KNEE LIFTER PARTS</u> (Supplied at an additional charge)	
545205 (833)	Bight Amplitude Slide Block Crank Set Screw (2)	504105 (809)	Rock Shaft Knee Arm Hub Set Screw
545260 (806)	Tension Releasing Lever Hinge Screw	504105 (809)	Rock Shaft Knee Plate Set Screw
545340 (806)	Bight and L-C-R Position Lever Stop Plate Set Screw (2)	504105 (809)	Rock Shaft Lifting Arm Hub Set Screw
545354 (804)	Bight Amplitude Slide Block Cap Screw	504105 (809)	Rock Shaft Lifting Arm Set Screw
545413 (803)	Bight and L-C-R Position Lever Screw Pin Nut	504105 (809)	Rock Shaft Stop Dog Set Screw (2)
545471 (828)	Tension Regulating Thumb Nut	504510 (809)	Rock Shaft Knee Arm Clamping Nut
545474 (873)	Tension Regulating Thumb Nut Lock Nut	505397	Rock Shaft
545766	Arm Shaft (upright) Bushing (lower)	505398	Rock Shaft Hanger (2)
545767	Arm Shaft (upright) Bushing (upper)	505399	Rock Shaft Knee Arm
545814	Feed Regulating Stud Bushing	505400	Rock Shaft Knee Arm Hub with 504105
545820	Feed Regulating Stud Lock Pin Spring	505401	Rock Shaft Knee Arm complete, Nos. 504510, 505399, 505400 and 505402
545931	Feed Reverse Lever Hinge Stud Flanged Bushing	505402	Rock Shaft Knee Plate with 504105
545947	Feed Reverse Lever Link Spring	505403	Rock Shaft Lifting Arm
545948	Feed Reverse Lever Hinge Stud Collar with two 504048	505404	Rock Shaft Lifting Arm Hub with two 504105
546320	Hand Wheel (for treadle drive)	505405	Rock Shaft complete, Nos. 505397, 505401, 505403, 505404, two each 505398, 505651, and four 549295
547670	Bight Amplitude Regulating Plate Thumb Screw Washer (2)	505651	Rock Shaft Stop Dog with 504105 (2)
547671	Bight and L-C-R Position Lever Thumb Stud Nut Spring Washer	549295 (819)	Rock Shaft Hanger Wood Screw (1 in. No. 9) (4)
549046 (853)	Face Plate Screw (2)	<u>DRIP PAN</u> (Supplied at an additional charge)	
549068 (803)	Zigzag Triangular Cam Set Screw (2)	541735	Drip Pan with four 546920
549119 (850)	Bight Amplitude Slide Block Crank Shaft Knob Set Screw	546920	Drip Pan Nail (No. 16 x 25) (4)
549234 (809)	Bight Amplitude Slide Block Crank Screw Pin	<u>BIGHT AMPLITUDE KNEE CONTROLLER</u> (Supplied at an additional charge)	
549285 (803)	Bight and L-C-R Position Lever Screw Pin	541744	Bight Amplitude Slide Block Crank Knee Operating Bell Crank
549286 (819)	Bight and L-C-R Position Lever Thumb Stud	541747	Bight Amplitude Slide Block Crank Knee Operating Connection
549287 (832)	Bight Amplitude Regulating Plate Thumb Screw (2)	541748	Bight Amplitude Slide Block Crank Knee Operating Connection Cutter Pin
549288 (830)	Bight Amplitude Slide Block Crank Link Hinge Screw (2)		
549288 (830)	Presser Bar Lifting Shaft Arm Connecting Rod Joint Hinge Screw		
549289 (803)	Feed Regulating Stud		
549290 (819)	Zigzag Stitch Regulator Fork Eccentric Connection Pin Set Screw		
549294 (805)	Arm Screw		
549330 (810)	Presser Bar Lifting Shaft Link Hinge Screw		

NUMERICAL LIST OF PARTS FOR MACHINE 200

<u>PART NO.</u>	<u>DESCRIPTION</u>	<u>PART NO.</u>	<u>DESCRIPTION</u>
2102	Tension Disc (2)	504070 (850)	Feed and Feed Lifting Eccentric Set Screw
11170	Presser Bar Spring Washer	504071 (833)	Feed Lifting Rock Shaft Crank Connecting Rod Cap Screw (2)
32618	Clamp Stop Motion Clamp Flanged Bushing	504071 (833)	Feed Reverse Lever Link Clamping Screw
32758	Thread Take-up Spring	504072 (803)	Feed Lifting Rock Shaft Screw Center (2)
36555	Thread Cutter and Holder	504072 (803)	Feed Rock Shaft Screw Center (2)
45339	Feed Regulating Stud Head Stop Pin	504074 (852)	Feed Regulating Stud Head Cap Screw
45339	Tension Regulating Thumb Nut Engaging Pin	504077 (803)	Needle Bar Connecting Link Adjusting Screw
52016	Presser Bar Lifter	504079 (830)	Needle Bar Crank Position Screw
52024	Thread Take-up Lever Link	504083 (852)	Presser Regulating Thumb Screw
52130	Thread Take-up Lever Thread Eyelet Bushing	504086 (806)	Rotating Hook Bobbin Case Tension Regulating Screw
52454	Thread Retainer	504087 (806)	Rotating Hook Bobbin Case Tension Spring Screw
55623	Rotating Hook Bobbin	504088 (803)	Rotating Hook Section Screw (3)
56024	Feed Connecting Link	504090 (803)	Needle Clamp Thread Guard Set Screw
56046	Presser Bar Spring	504090 (803)	Rotating Hook Thread Guard Screw (4)
56073	Bell Crank Spring	504091 (803)	Needle Bar Set Screw
99646	Arm Shaft (horizontal) Flanged Pushing (back)	504094 (850)	Feed Regulating Stud Bushing Set Screw
99665	Presser Bar (hollow)	504094 (850)	Thread Retainer Set Screw
99686	Arm Shaft (horizontal) Flanged Pushing (back and front) Oil Pad (felt) (2)	504094 (850)	Zigzag Triangular Cam Shaft Set Screw
99691	Tension Indicator Flange Washer	504095 (850)	Thread Take-up Crank Position Screw
125314	Tension Spring	504099 (809)	Bell Crank Bracket Screw (2)
154756 (851)	Clamp Stop Motion Clamp Stop Screw	504101 (850)	Arm Shaft (unright) Bevel Gear (lower) Set Screw (2)
154759 (850)	Feed Connecting Link Hinge Screw (2)	504101 (850)	Rotating Hook Drive Shaft Bevel Gear (back) Set Screw (2)
154759 (850)	Feed Forked Connection Hinge Screw	504101 (850)	Rotating Hook Drive Shaft Bevel Gear (front) Set Screw (2)
154759 (850)	Feed Lifting Rock Shaft Crank Connecting Rod Hinge Screw	504101 (850)	Rotating Hook Shaft Bevel Gear Set Screw (2)
154789 (809)	Bed Slide Spring Screw (2)	504101 (850)	Thread Take-up Crank Set Screw
154884	Bed Slide Spring	504102 (833)	Arm Shaft (unright) Bevel Gear (upper) Set Screw (2)
154981 (819)	Feed Connecting Link Hinge Screw Nut (2)	504153 (850)	Arm Shaft (horizontal) Flanged Pushing (front) Set Screw
154981 (819)	Feed Forked Connection Hinge Screw Nut	504154 (805)	Right Amplitude Slide Block Guide Stud Set Screw
154981 (819)	Feed Lifting Rock Shaft Crank Connecting Rod Hinge Screw Nut	504156 (825)	Arm Side Cover Set Screw (4)
173616	Thread Guard (lower) Rivet	504145 (809)	Right Amplitude Regulating Plate Holder Set Screw (2)
504002 (850)	Feed Regulator Hinge Stud Flanged Bushing Set Screw	504150 (805)	Needle Bar Frame Hinge Screw
504002 (850)	Rotating Hook Drive Shaft Bushing (back) Set Screw	504159 (819)	Arm Top Cover Hinge (inner) Set Screw (3)
504002 (850)	Rotating Hook Drive Shaft Bushing (front) Set Screw	504159 (819)	Bed Plate Screw (2)
504002 (850)	Thread Take-up Lever Link Hinge Pin Set Screw	504159 (819)	Slack Thread Regulator Set Screw
504002 (850)	Thread Take-up Spring Regulator Set Screw	504159 (819)	Thread Guard (lower) Set Screw (2)
504002 (850)	Zigzag Triangular Cam Shaft Set Screw	504159 (819)	Throat Plate Screw (2)
504005 (852)	Clamp Stop Motion Clamp Screw	504167 (805)	Arm Screw (small)
504007 (850)	Rotating Hook Set Screw (3)	504502 (819)	Feed Bar Screw Center Nut (2)
504007 (850)	Rotating Hook Shaft Retainer Collar Screw (4)	504504 (819)	Feed Lifting Rock Shaft Screw Center Nut (2)
504010 (829)	Arm Top Cover Hinge (outer) Set Screw (3)	504504 (819)	Feed Rock Shaft Screw Center Nut (2)
504010 (829)	Arm Top Cover Shutting Plate Set Screw	504507 (809)	Right and L-C-R Position Lever Thumb Stud Nut
504010 (829)	Arm Top Cover Shutting Spring Set Screw	504509 (809)	Presser Bar Lifting Shaft Arm Connecting Rod Nut
504010 (829)	Right and L-C-R Position Lever Set Screw (2)	504751	Feed Lifting Rock Shaft Roller and Stud
504010 (829)	Needle Bar Connecting Link Guide Screw (2)	505001	Arm Dowel Pin (2)
504010 (829)	Rotating Hook Bobbin Case Holder Position Bracket Screw	505009	Clamp Stop Motion Clamp Washer
504010 (829)	Rotating Hook Shaft Bevel Gear Cover Screw	505322	Feed Forked Connection
504010 (829)	Thread Guard (upper) Set Screw	505326	Feed Lifting Rock Shaft Crank with 504019
504019 (850)	Arm Top Cover Spool Holder Bracket Screw (2)	505327	Feed Lifting Rock Shaft Crank Connecting Rod with two 504071
504019 (808)	Feed Lifting Rock Shaft Crank Clamping Screw	505328	Feed Lifting Rock Shaft Crank Connecting Rod Cap Oil Pad (felt)
504019 (808)	Feed Rock Shaft Crank Clamping Screw	505333	Feed Rock Shaft
504021 (809)	Arm Top Cover Shutting Plate Link Hinge Screw	505334	Feed Rock Shaft complete, Nos. 505333 and 505335
504027 (851)	Needle Clamp Thumb Screw	505335	Feed Rock Shaft Crank with 504019
504028 (850)	Arm Shaft (horizontal) Flanged Pushing (back) Set Screw	505339	Needle Bar Crank with 504079, 504095 and 504101
504028 (850)	Arm Shaft (horizontal) Worm Gear Set Screw (2)	505343	Presser Bar Guide Bracket with 504028
504028 (850)	Presser Bar Guide Bracket Set Screw	505351	Rotating Hook Bobbin Case Hinge Nos. 505353, 505354 and 505355
504029 (833)	Presser Bar Lifting Shaft Arm Set Screw	505353	Rotating Hook Bobbin Case Latch
504032 (805)	Rotating Hook Bobbin Case Latch Stop Screw	505354	Rotating Hook Bobbin Case Latch Lever
504047 (830)	Tension Stud Set Screw	505355	Rotating Hook Bobbin Case Latch Lever Fulcrum Pin
504048 (833)	Right Amplitude Slide Block Crank Shaft Bushing Collar Set Screw (2)	505356	Rotating Hook Bobbin Case Latch Spring
504048 (833)	Right Amplitude Stop Stud Set Screw (2)	505372	Thread Take-up Lever Link Hinge Pin
504048 (833)	Feed Reverse Lever Hinge Stud Collar Set Screw (2)	505374	Thread Take-up Spring Regulator
504048 (833)	Rotating Hook Drive Shaft Retainer Collar Screw (2)	505384	Bell Crank complete, Nos. 56073, 505417, 505418 and 505419
504051 (850)	Feed Dog Screw (2)	505407	Feed Bar Screw Center 504068 with 504502 (2)
504056 (830)	Presser Bar Lifter Pin Set Screw	505408	Feed Lifting Rock Shaft Screw Center 504072 with 504504 (2)
504057 (805)	Needle Bar Connecting Link Cap Screw	505408	Feed Rock Shaft Screw Center 504072 with 504504 (2)
504063 (825)	Presser Foot Screw	505408	Feed Rock Shaft Screw Center 504072 with 504504 (2)
504066 (833)	Arm Shaft (horizontal) Bevel Gear Set Screw (2)		
504067 (850)	Clamp Stop Motion Clamp Flanged Bushing Set Screw		
504068 (803)	Feed Bar Screw Center (2)		
504069 (833)	Feed and Feed Lifting Eccentric Position Screw		

NUMERICAL LIST OF PARTS FOR MACHINE 20U

<u>PART NO.</u>	<u>DESCRIPTION</u>	<u>PART NO.</u>	<u>DESCRIPTION</u>
505409	Thread Take-up Spring Regulator 505374 with 504047	541659	Needle Bar Connecting Link 541658 with 541662
505417	Bell Crank	541660	Needle Bar Connecting Link Guide
505418	Bell Crank Bracket	541661	Needle Bar Connecting Stud
505419	Bell Crank Hinge Pin	541662	Needle Bar Connecting Stud complete, Nos. 504091, 545001, 541661, 541664 and 541665
505427	Rotating Hook Drive Shaft Retainer Collar with two 504048	541663	Hand Wheel (disc 2-1/4 in. dia.) (for electric drive)
505428	Arm Shaft (horizontal) Flanged Bushing (front)	541664	Needle Bar Connecting Stud Hinge Pin
505513	Arm Oil Tube Packing (cotton)	541665	Needle Bar Connecting Stud Hinge Pin Washer
505571	Zigzag Triangular Cam Shaft Oil Wick	541666	Needle Bar Frame
505658	Presser Bar Lifter Pin	541667	Needle Clamp
540163	Arm Top Cover Spool Holder Cushion	541668	Needle Clamp complete, Nos. 541667, 541669, 504090 and 504027
540435	Feed Regulating Stud Lock Pin	541669	Needle Clamp Thread Guard
540467	Tension Regulating Thumb Nut 545471 with 45339	541670	Presser Foot (spring hinged)
540472	Thread Guard (upper)	541671	Rotating Hook with three 504007
541603	Arm Oil Tube (for thread take-up lever link)	541673	Rotating Hook complete, Nos. 541671, 541675, 541694, three 504088 and four 504090 (for agents only)
541605	Arm Shaft (horizontal)	541674	Rotating Hook 541673 with 541680
541606	Arm Shaft (horizontal) Bevel Gear with two 504066	541675	Rotating Hook 541674 with 541678
541607	Arm Shaft (horizontal) Worm Gear with two 504028	541676	Rotating Hook Bobbin Case
541608	Arm Shaft (upright)	541677	Rotating Hook Bobbin Case 541676 with 541764, 504086 and 504087
541609	Arm Shaft (upright) Bevel Gear (lower) with two 504101	541678	Rotating Hook Bobbin Case complete, Nos. 504032, 541677, 505351 and 505356
541610	Arm Shaft (upright) Bevel Gear (upper) with two 504102	541679	Rotating Hook Bobbin Case 541678 with 541680 (for agents only)
541611	Arm Side Cover	541680	Rotating Hook Bobbin Case Holder
541614	Arm Top Cover Hinge	541681	Rotating Hook Bobbin Case Holder Position Bracket
541616	Arm Top Cover Shutting Spring	541683	Rotating Hook Drive Shaft
541618	Bed Plate	541684	Rotating Hook Drive Shaft Bevel Gear (back) with two 504101
541619	Bed Slide	541685	Rotating Hook Drive Shaft Bevel Gear (front) with two 504101
541620	Bed Slide complete, Nos. 541619, 154884 and two 154789	541686	Rotating Hook Drive Shaft Bushing (back)
541621	Right and L-C-R Position Block	541687	Rotating Hook Drive Shaft Bushing (front)
541622	Right and L-C-R Position Block complete, Nos. 541621, two each 541625 and 545082	541688	Rotating Hook Shaft
541623	Right and L-C-R Position Lever with 549285 and 545413	541689	Rotating Hook Shaft Bevel Gear with two 504101
541624	Right and L-C-R Position Lever Arm	541690	Rotating Hook Shaft Bevel Gear Cover
541625	Right and L-C-R Position Lever Stop Plate (2)	541691	Rotating Hook Shaft Bushing (long)
541626	Right Amplitude Regulating Plate (left)	541692	Rotating Hook Shaft Bushing (short)
541627	Right Amplitude Regulating Plate (right)	541693	Rotating Hook Shaft Retainer Collar with two 504007 (2)
541628	Right Amplitude Regulating Plate Holder	541694	Rotating Hook Thread Guard
541629	Right Amplitude Regulating Plate Holder and Right Amplitude Regulating Plate, Nos. 541626, 541627, 541628, 541630 and two each 504048, 541643, 541670, 549287	541695	Set of Gears (lower, back) Nos. 541684 and 541609
541630	Right Amplitude Regulating Plate Spring	541696	Set of Gears (lower, front) Nos. 541685 and 541689
541631	Right Amplitude Slide Block	541697	Set of Gears (upper) Nos. 541606 and 541610
541632	Right Amplitude Slide Block Crank with 549234 and two 545205	541698	Slack Thread Regulator
541633	Right Amplitude Slide Block Crank 541632 with 541634, 541641, 541624, 541642 and two 549288	541699	Tension complete, Nos. 32758, 99691, 125314, 505409, 541702, 541704, 549857, 549858 and two 2102
541634	Right Amplitude Slide Block Crank Link	541700	Tension Releasing Lever
541635	Right Amplitude Slide Block Crank Shaft	541701	Tension Releasing Lever Spring
541636	Right Amplitude Slide Block Crank Shaft Bushing	541702	Tension Releasing Pin
541637	Right Amplitude Slide Block Crank Shaft Bushing Collar with two 504048	541703	Tension Stud
541638	Right Amplitude Slide Block Crank Shaft Knob	541704	Tension Stud 541703 with 540467 and 545474
541639	Right Amplitude Slide Block Crank Spring	541705	Thread Guard (lower) complete, Nos. 541732, 173616 and 541752
541640	Right Amplitude Slide Block Crank Spring Bracket	541706	Thread Take-up complete, Nos. 541709, 504057, 541695, 541707 and 505372
541641	Right Amplitude Slide Block Guide with 504134	541707	Thread Take-up Crank
541642	Right Amplitude Slide Block Guide Stud	541708	Thread Take-up Lever with 52130
541643	Right Amplitude Stop Stud (2)	541709	Thread Take-up Lever complete, Nos. 541708 and 52024
541644	Face Plate	541710	Throat Plate
541645	Feed and Feed Lifting Eccentric with 504069 and 504070	541711	Zigzag Stitch Regulator Fork
541646	Feed Bar	541712	Zigzag Stitch Regulator Fork Eccentric Connection Pin
541647	Feed Dog	541713	Zigzag Stitch Regulator Fork Retaining Washer (2)
541648	Feed Lifting Rock Shaft with 504751	541714	Zigzag Triangular Cam
541649	Feed Lifting Rock Shaft complete, Nos. 541648 and 505326	541715	Zigzag Triangular Cam complete, Nos. 541714, 541717, two each 549068 and 541713
541650	Feed Regulating Stud Head with 45339	541716	Zigzag Triangular Cam and Zigzag Triangular Cam Shaft complete, Nos. 541715, 541718 and 505571
541651	Feed Regulator with 545045	541717	Zigzag Triangular Cam Gear
541652	Feed Regulator Hinge Stud	541718	Zigzag Triangular Cam Shaft
541653	Feed Regulator Hinge Stud Flanged Bushing	541719	Zigzag Triangular Cam Shaft Bushing with 504094
541654	Feed Reverse Lever with 545046		
541655	Feed Reverse Lever Hinge Stud		
541656	Feed Reverse Lever Link with 504071		
541657	Needle Bar (hollow)		
541658	Needle Bar Connecting Link with 504077		